

MyoClamp System

User Guide

revision 2.0

This page is intentionally left blank.

Copyright 2026 IonOptix LLC

All rights reserved. No parts of this work may be reproduced in any form or by any means - graphic, electronic, or mechanical, including photocopying, recording, taping, or information storage and retrieval systems - without the written permission of the publisher.

Products that are referred to in this document may be either trademarks and/or registered trademarks of the respective owners. The publisher and the author make no claim to these trademarks.

While every precaution has been taken in the preparation of this document, the publisher and the author assume no responsibility for errors or omissions, or for damages resulting from the use of information contained in this document or from the use of programs and source code that may accompany it. In no event shall the publisher and the author be liable for any loss of profit or any other commercial damage caused or alleged to have been caused directly or indirectly by this document.

Document date: March 24, 2026

Printed: April 17, 2026 in Westwood, Massachusetts, USA

Research Use Only

This product is intended for research purposes only. It is not certified for clinical applications (including diagnostic purposes). Use of this product in uncertified applications is in violation of FDA regulations.

Table of Contents

Table of Contents	iv
Safety Precautions	1
Statement of Conformity	1
Intended Use	1
Disposal	2
Warranty	2
Introduction	3
Description	3
Features	3
Hardware	4
Force Transducer	4
Force Transducer Bridge Amplifier	6
Voice Coil Motor	9
Motor Controller	10
Chamber Attributes and Fluid Height Adjustment	13
Calibrating the Force Transducer	17
Assembling the System	22
Appendix: Troubleshooting.....	30
Index.....	31

Safety Precautions



To ensure reliability and safety, we recommend using the instrument according to the guidelines described in this manual. All safety and operating instructions should be read and understood before use.

Electric shock risk! Do not remove instrument cover. There are no user-serviceable parts inside. Refer servicing to IonOptix technical support (support@ionoptix.com). Static electricity can damage electronic components. Take care to discharge yourself before handling the device.

Please adhere to the following safety guidelines:

- Unplug the instrument from the wall before cleaning.
- Keep the instrument free from moisture, water, and dust.
- Do not place instrument on unstable surface and do not drop the device.
- If ventilation slots are present on instrument panels, keep clear of obstructions.
- All cables and power supply cords should be routed so as to not cause a hazard. Use only supplied or approved/recommended cables.
- Ensure instrument is not situated near a heat source.

Statement of Conformity



This instrument carries the CE mark and meets the appropriate EU directives.

Intended Use



This product is intended for **research purposes only**. It is not certified for clinical applications (including diagnostic purposes). Use of this product in uncertified applications is in violation of FDA regulations.

IonOptix products are intended to be installed, used, and operated under the supervision of an appropriately qualified life-science researcher.

Disposal

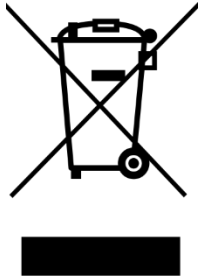

Forward to recycling center or return to manufacturer. Unwanted equipment bearing the Waste Electrical and Electronic Equipment (WEEE) Directive symbol requires separate waste collection. For a product labeled with this symbol, either forward to a recycling center or contact your nearest IonOptix representative for methods of disposal at the end of its working life.

Warranty

This IonOptix instrument is warranted for a period of one (1) year from delivery under normal use and conditions, and will operate in material conformance with applicable IonOptix specifications or standards.

This warranty does not apply to any defect caused by failure to provide a suitable operating environment, any other excluded use, or any other abuse, misuse, or neglect off the instrument.

Introduction

Description

MyoClamp Systems are useful for simultaneous recording of contractile force and Ca^{2+} handling characteristics in intact muscle preparations, like cardiac papillary muscles or living myocardial slices, with dimensions of millimeters to centimeters. To call the muscle 'intact' means that the cell membranes are excitable, and electrical stimulation will elicit Ca^{2+} release into the cytosol of the muscle cells leading to force production and muscle contraction.

The most notable components are (i) the force transducer, (ii) the length controller, and (iii) the chamber, which allows for submersion of the muscle in solution.

Features

A. Muscle types. The muscle chamber is designed to be used for intact, excitable muscles up to 2 cm in length:

1. Cardiac slices (mouse, rat, rabbit, cat, dog, pig, human)
2. Cardiac papillary muscle (mouse, rat, rabbit, cat, dog, pig)
3. Cardiac endocardial strips or trabeculae (mouse, rat, rabbit, cat, dog, pig, human)
4. Cardiac epicardial strips (mouse, rat, rabbit, cat, dog, pig, human)
5. Skeletal muscles, e.g., soleus, extensor digitorum longus (EDL), gastrocnemius, cremaster (mouse, rat)
6. Bioengineered muscle from stem cells (all types)

B. Stimulation through platinum clips/electrodes. Stimulation of linear muscle samples (2-5 above) is elicited by passing electrical current directly through the sample, therefore guaranteeing the highest probability of eliciting a contraction. The other two sample types (1 and 6 above) are best excited with field electrodes.

C. Simultaneous force and fluorescence recordings. A clear cover slip forms the bottom of the chamber and, if placed on an inverted microscope fitted with a long working distance objective, allows fluorescence light detection. It should be noted that the muscle will be placed 1-2 mm above the surface of the cover slip, therefore the objective should have a working distance greater than ~ 1.5 mm.

Hardware

The following sections describe the hardware aspects of the MyoClamp System. The hardware discussion is broken into the following sections:

- Force Transducer
- Front and Back Panel Controls for Force Transducer Bridge Amplifier
- Voice Coil Motor
- Front Panel Connections for Motor Controller
- Length Adjustment
- Chamber Attributes and Fluid Height Adjustment

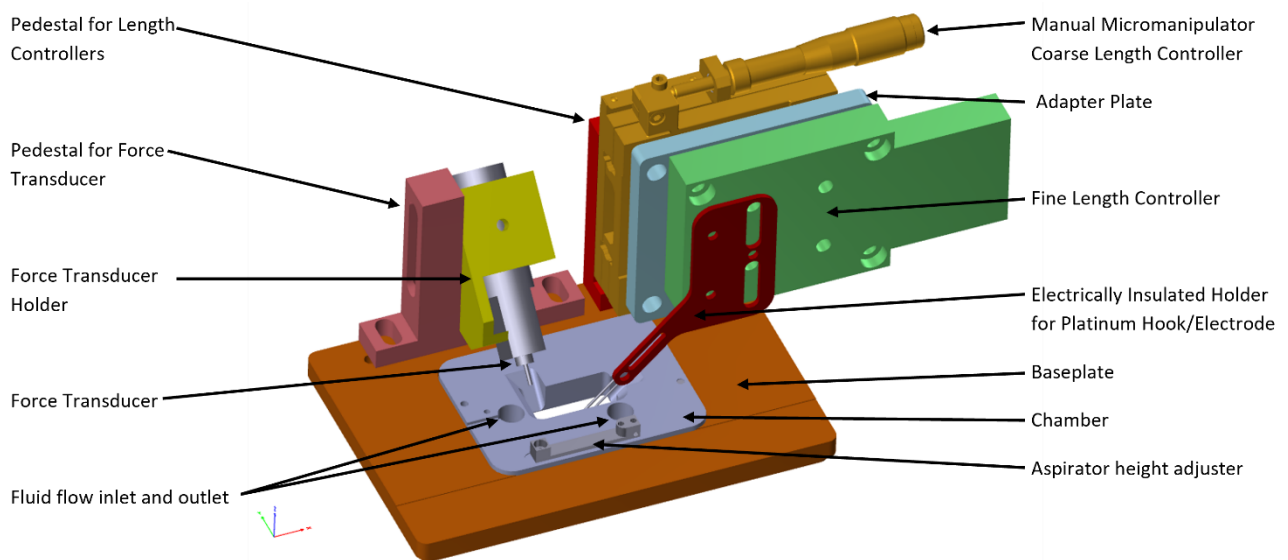

Force Transducer

The force transducer arrives preassembled. The KoForce headstage has a length of stainless steel tubing that holds a platinum rod bent to form a hook.

IMPORTANT: Make sure the hook is oriented such that a pull on the hook will be recorded as a positive deflection by the force transducer. The wire that extends from the body is visible from the front (see photo below).

The force transducer was designed by Dr. Konrad Güth at Myotronic, Heidelberg, Germany. Dr. Güth developed many of the techniques and instruments used in the field of muscle research.

His force transducer is especially useful for two reasons. First, it is based on detecting the deflection of a mechanical lever using an LED light source and light sensor. It is that simple. It is also electrically isolated from the cantilever, which can now be used to pass current for stimulation of the muscle sample. Second, this design is robust, meaning the force transducer is difficult to physically break. That is an important feature when you consider that the experimentalist must load the muscle sample delicately.

The force transducer has been calibrated at our factory location. Refer to force calibration spreadsheet provided with the bridge amplifier for the actual values of the calibration in units of mN / V. We recommend that the user recalibrates the force transducer at least once per year, or more often if it is subject to frequent use. The section in this manual entitled [Calibrating the Force Transducer](#) will guide the user through the recalibration when needed.

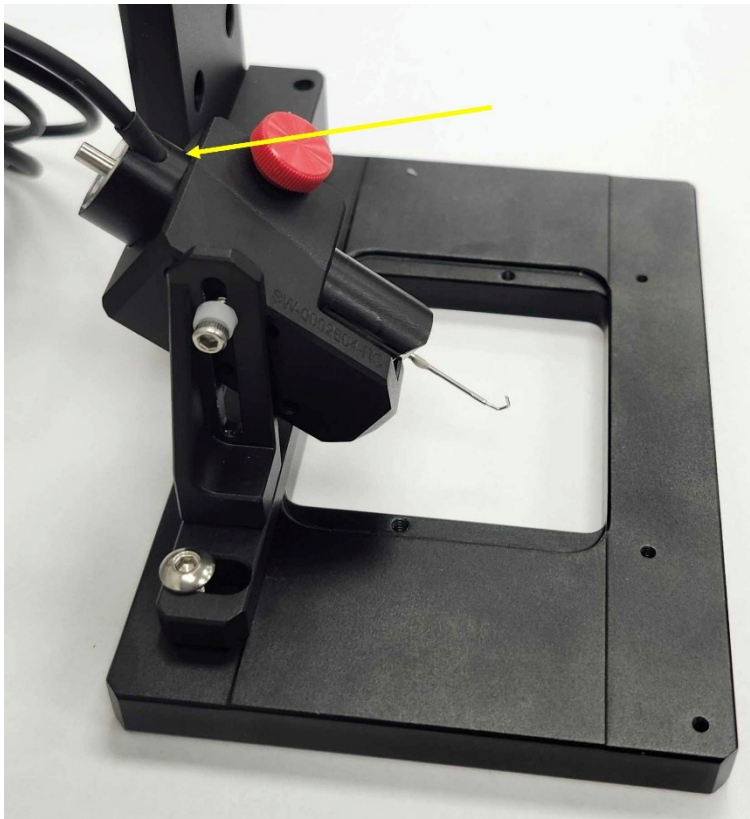

Correct orientation: wire (yellow arrow above) is facing the front of the chamber and visible.

Force Transducer Bridge Amplifier

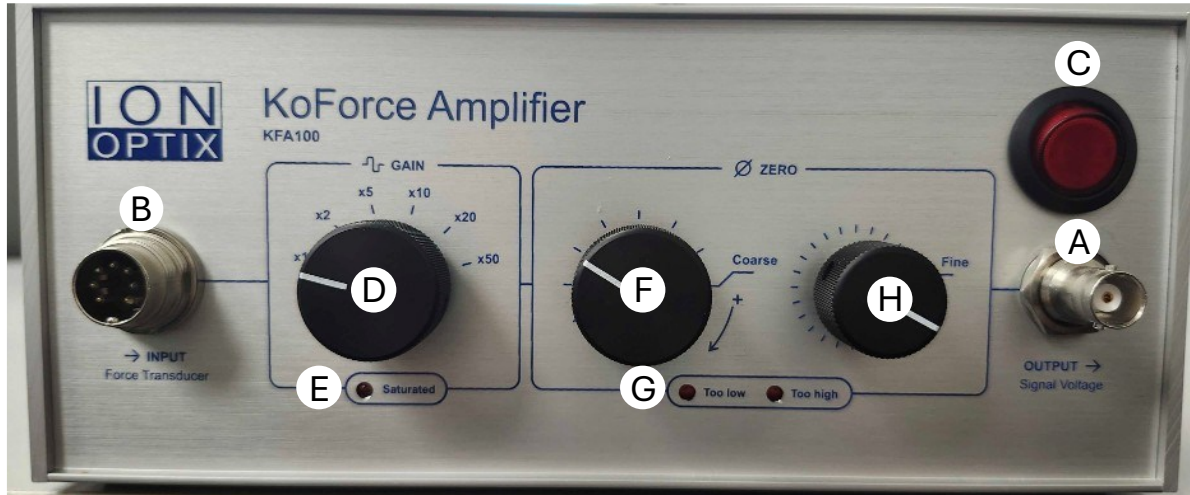

Front Panel



Back Panel

The above figures show the front and back panel of the KoForce Transducer Bridge Amplifier. The individual areas highlighted in the figure are:

- A. Output BNC Jack
- B. Force Transducer Connector
- C. Power Switch
- D. Gain Setting
- E. Overload Indicator Light
- F. Coarse Offset Setting
- G. Offset Indicator Lights
- H. Fine Offset Setting
- I. Power Plug and Fuse

Each area is further discussed below.

Output BNC Jack

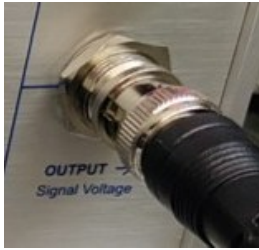

This BNC jack provides the voltage that represents the force detected by the transducer. Connecting this jack to an oscilloscope or A/D converter allows the user to monitor and record the force in real time.

Force Transducer Connector



This seven pin male connector accepts the female counterpart attached to wires that run to the force transducer.

Power Switch



Turn on the power to the bridge amplifier using this power switch on the front panel. When the light is on, the bridge amplifier is operating.

Gain Setting and Overload Indicator Light



The gain setting knob allows the user to choose the amplification (1-50 X) applied to the force signal. When the overload indicator light is on, the gain is too high to record the force. The best remedy is to reduce the gain setting.

Coarse Offset Setting and Offset Indicator Lights



At the start of making a measurement, it is important to set the offset that corresponds to zero force. Typically, the muscle is placed on the hooks, but slack with no tension. The offset indicator lights guide the proper setting. If the indicator lights show 'low', then turn the knob up (clockwise) until neither light is on or until the 'high' light comes on. At that point, adjust the fine offset setting. If the indicator lights show 'high' at the start, then turn the knob down until neither light is on or the 'low' light comes on. Again, at that point, adjust the fine offset setting.

Fine Offset Setting



The fine offset knob is adjusted to assure that the force transducer is indicating zero force when force transducer has a muscle loaded, but there is no contractile force applied. After having adjusted the coarse offset, adjust the fine offset until zero volts are registered. The user will need some way to detect the voltage, either a voltmeter, oscilloscope, or IonWizard.

Power Plug and Fuse

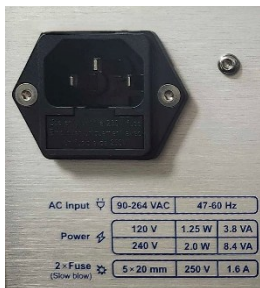

The power cord is plugged into the receptacle. The factory will have set the receptacle for 120 V or 240 V depending on your country. The fuse housing holds a 1.6 A fuse.

Always unplug device before checking fuse!

Voice Coil Motor

The motor (model V-522 by Physik Instrumente) is called a 'voice coil' motor because it is driven by electromagnets like those used in speakers and microphones. Magnetic control allows for very fast translations. The motor provided with the system has a 5 mm range (-2.5 mm to +2.5 mm from its center position) and can move as quickly as 250 mm/s.

The resolution of the V-522 is 20 nm.

This voice coil can be controlled by an analog voltage (1 mm / V), where positive voltages correspond to muscle lengthening.

The position of the voice coil is similarly monitored using an analog voltage (1 mm / V).

Additional specifications can be found on the V-522 datasheet.

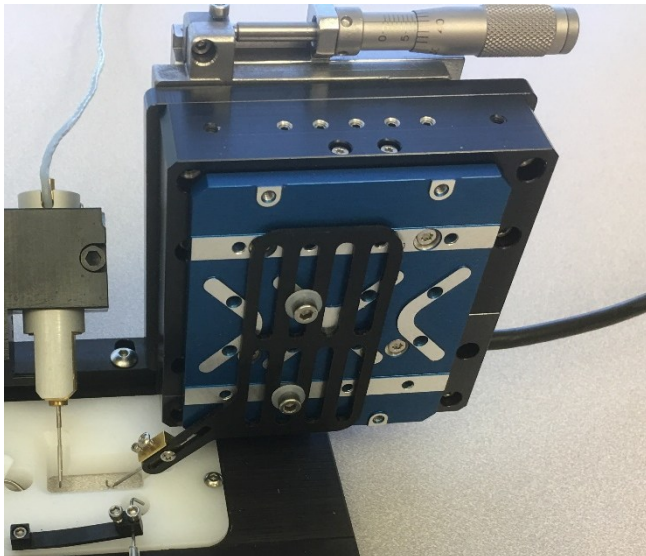

Motor Controller



The above figure shows the front panel of the TMC100 Tissue Motor Controller. The individual areas highlighted in the figure are:

- A. Motor Connector
- B. Analog Input BNC Connector
- C. Analog Output BNC Connector
- D. Power Switch

Motor Connector



Connect the motor cable to the Motor Connector (15-pin DSUB). Be sure to tighten both anchoring screws securely.

Analog Input BNC Connector



This BNC jack connection allows for analog control of the target motor position. It should be connected via a BNC cable to a digital-to-analog BNC jack on the Fluorescence System Interface front panel (see [Assembling the System](#) for more detailed instructions).

Analog Output BNC Connector



This BNC jack connection allows for monitoring the actual motor position in real time. It should be connected via a BNC cable to an analog-to-digital BNC jack on the Fluorescence System Interface front panel (see [Assembling the System](#) for more detailed instructions).

Power Switch



Turn on the power to the motor controller using this power switch on the front panel. When the light is on, the motor is operating.

Stay clear of the motor when power is applied. The table will move rapidly.

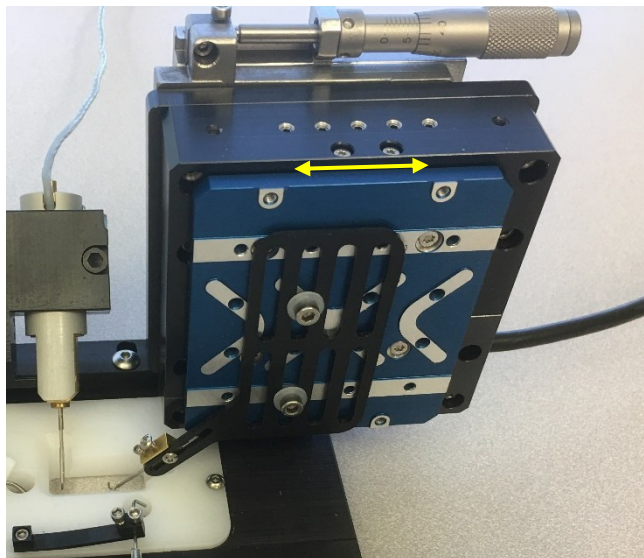

THE BLUE FACE (OR TABLE) WILL MOVE RAPIDLY BACK AND FORTH WHEN POWER IS APPLIED.

STAY CLEAR!

Manual Length Adjustment

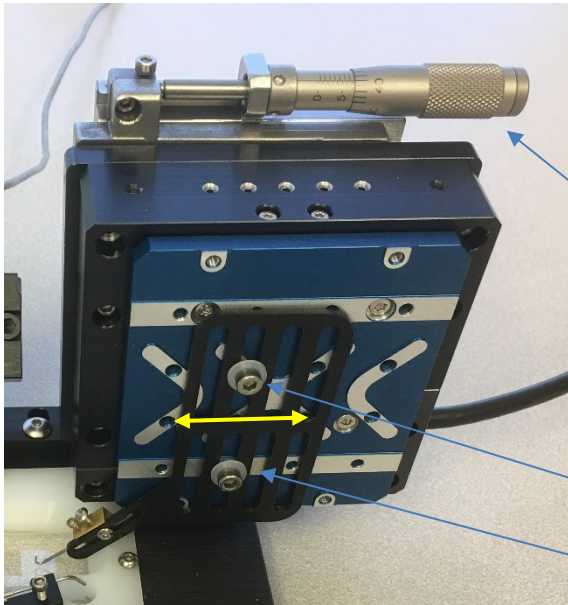

The manual micromanipulator can be turned to translate the motor assembly 12.5 mm in both directions from its center position. The total travel possible is 25 mm.

Turn the thumb screw here. The motor assembly including the hook will be translated. If a muscle is attached to the hook, it is highly recommended that the screw be turned slowly.

If the user finds that they are consistently using short muscles, it may be worthwhile to adjust the position of the beak to accommodate shorter muscles. Conversely, if the user is consistently using long muscles, adjust the beak to accommodate longer muscles.

Chamber Attributes and Fluid Height Adjustment

There are two types of chambers available. One is a narrow chamber (left) and assumes electrical stimulation will be passed through the platinum hooks. This is especially useful for cardiac papillary muscle and small skeletal muscles (e.g., from mice or rats) that can be shorter than 20 mm tendon to tendon. The other is a wide chamber (right) designed for cardiac slices and other wider tissue preparations. These preparations are usually around 10 mm wide and 10 mm long. This wider chamber comes with bath electrodes for field stimulation.

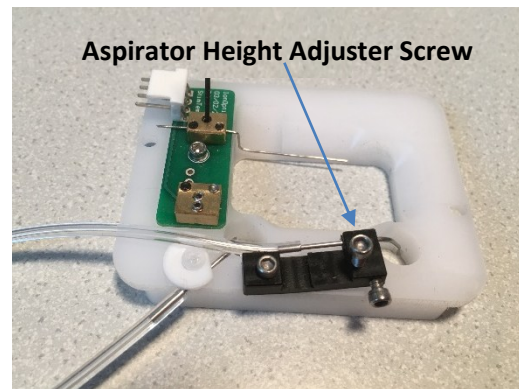
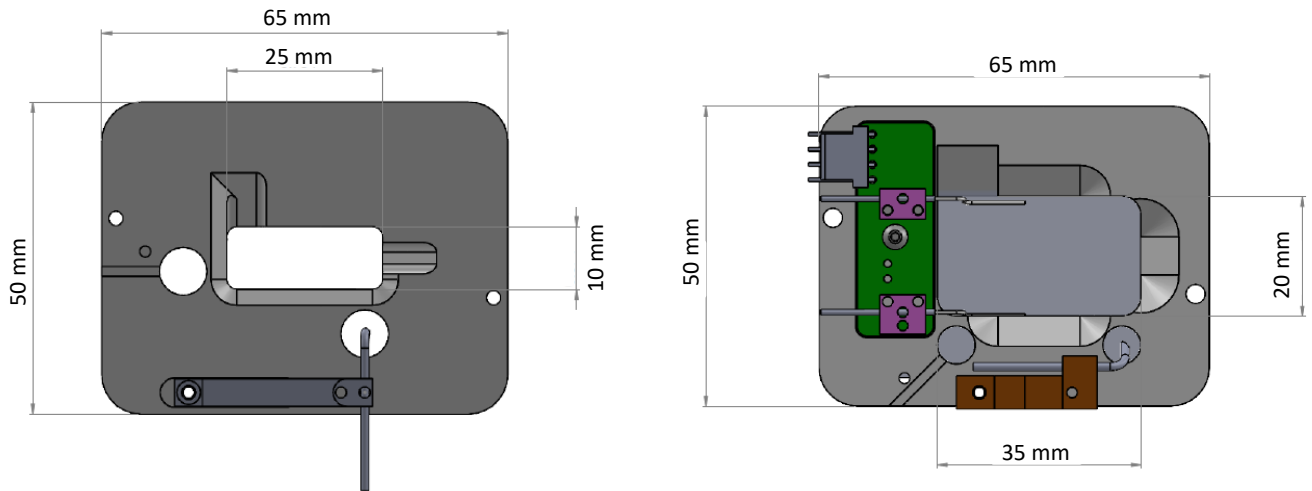

Both chambers utilize an aspirator height adjuster to define the height of the fluid in the chamber. Turn the screw, and the aspirator height will raise or lower.

Repair of Coverslip

The chamber features a main rectangular opening where the sample will be examined, and two circular side openings, which permit smoother fluid flow. A no 1 or 1.5 thickness coverslip (45 mm x 50 mm) is glued (silicon glue) onto the bottom of the chamber to provide a bottom to all the openings.

The Delrin chamber will not likely break, but the coverslip might break or become unglued. A few extra 45 mm x 50 mm coverslips are provided for this eventuality.

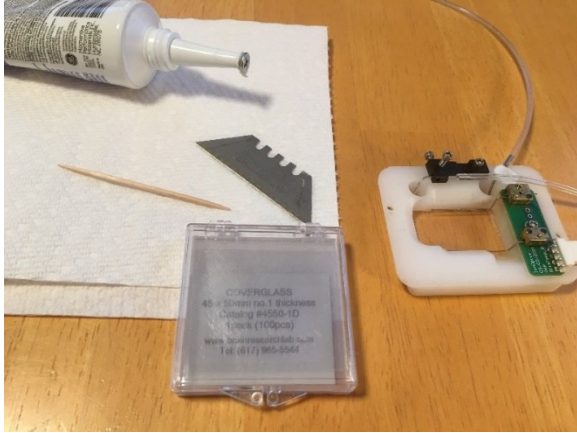

In case the coverslip breaks, or the solution begins to leak from under the coverslip, the user must replace the coverslip.

(The wide chamber is used as an example here for removing the coverslip, but the process is the same for the narrow chamber.)

First, gather the following: leaky chamber, replacement coverslips, razor blade, small wooden stick, clear silicone glue (aquarium glue will also do), and paper towel.

Remove the coverslip using the razor blade. Dispose of the coverslip appropriately (e.g., a sharps bin).



Make sure all the glue is removed and the bottom surface of the chamber is clear of any residual glue.

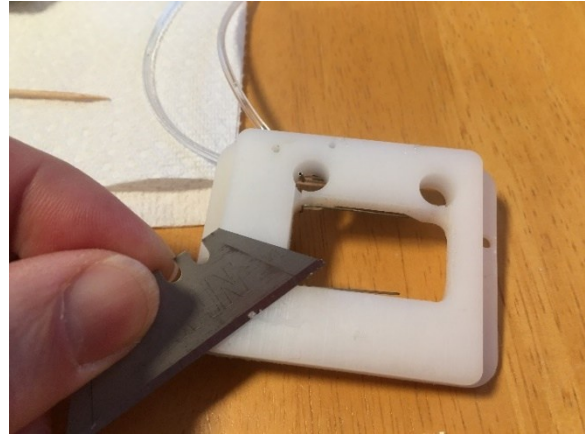

The narrow chamber is shown here as an example for regluing a coverslip. Apply silicon glue to the bottom.

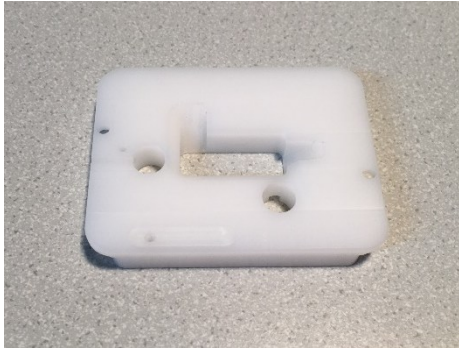

Cover about 10 mm from the inside edges. Keep glue out of channel spaces and away from outside edges. Carefully place the 45 x 50 mm coverslip to cover the bottom.

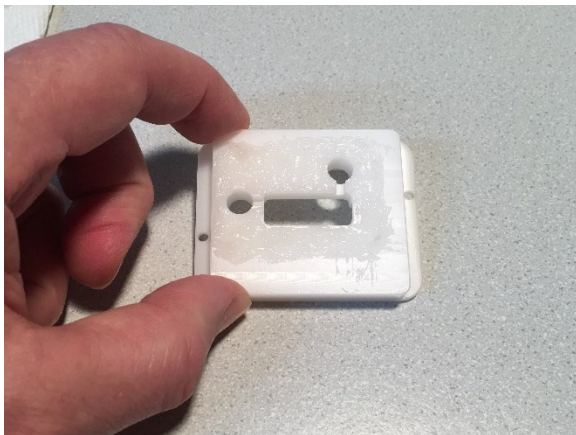

Make sure the coverslip does not reach over the outside edges. Push the coverslip down carefully using the back of the forceps to ensure it is glued at all possible areas.

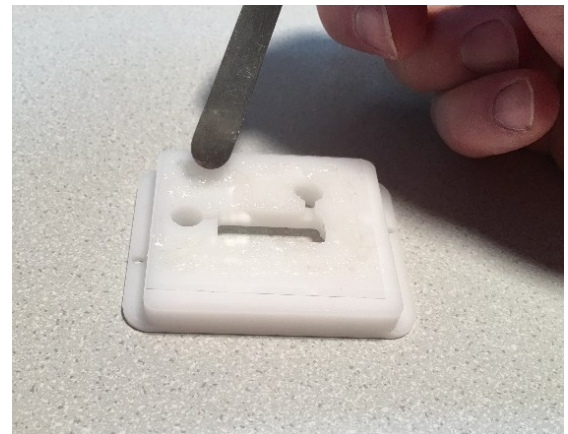

Clean up any glue hanging over the outside edge. Some glue is expected to squeeze under the inside edge and is acceptable.

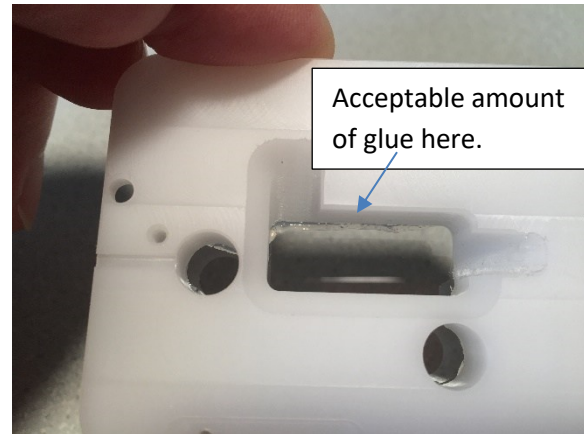
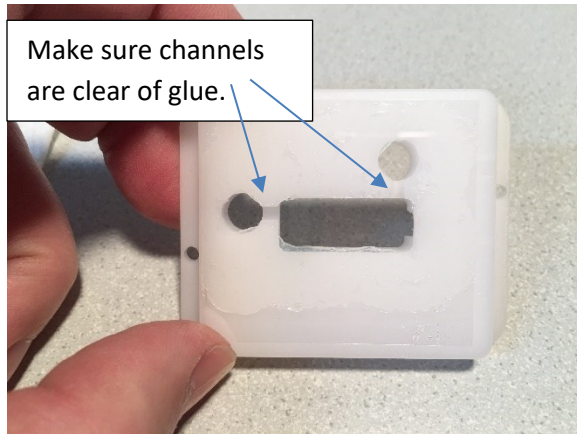

Let this chamber sit 24 hours to allow the glue to cure.

Fluid Flow Accessories

Hypodermic stainless steel tubing (20 G, 25 mm long) can be bent to dip into the side chambers and allow for fluid flow.

Tygon tubing, 0.8 mm ID (1/32"), 2.4 mm OD (3/32"), 0.8 mm wall (1/32") is good for fitting the 20 G tubing into a fluid flow circuit.

Blunt hypodermic stainless steel needle (18 G or 20 G, 25 mm long) is used to establish fluid flow. The lure lock fitting makes it easy to attach to the perfusion system (not provided by IonOptix).

Calibrating the Force Transducer

There may come a time when you want to double-check the force transducer calibration. This may happen if the force transducer has been bumped calling the calibration into question, or if it has been used frequently or for an extended period of time.

First, you will need calibration weights.

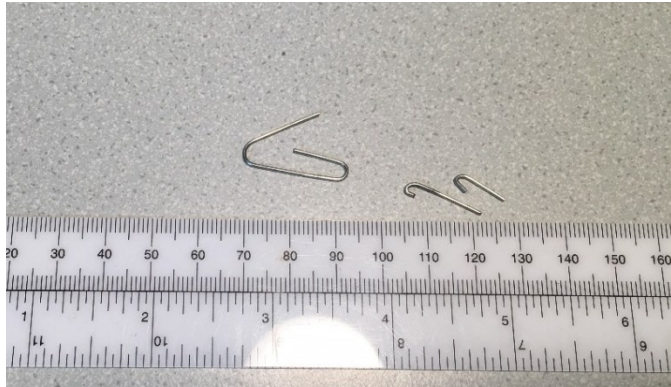

Take a standard paper clip and cut into different lengths from 5-30 mm long. Straighten and bend the pieces to make at least five different sized 'shepherd crooks.'



Now, weigh each of these pieces using the laboratory scale.

The pieces should range from 20 mg to as much as 200 mg, which corresponds to roughly 0.2 mN to 2 mN of force, respectively. If you expect higher forces from your muscle samples, then make additional heavier weights.

Use a voltmeter to monitor the output signal voltage from the KoForce amplifier (see pics below).

This is the setup for calibrating the force transducer. Place the force transducer so that gravity pulls on the hook in the same direction that a muscle would pull on the hook. You do not need a special jig like that shown in the photos. The force transducer just needs to be flat and stabilized. A book could be used to stabilize the body of the force transducer.

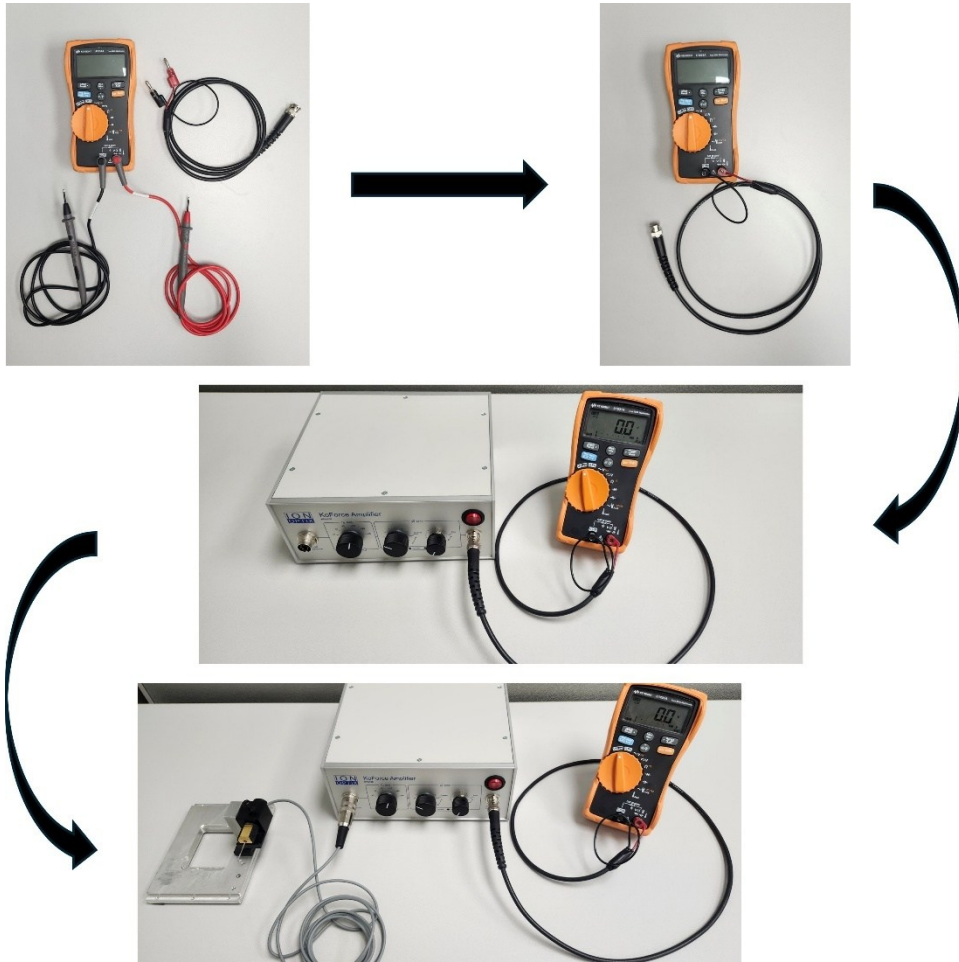

It is particularly important that the transducer is oriented as shown to ensure a positive voltage.

Note that the hook is flat and pointed to the right. The wire at the top is also oriented to the right.

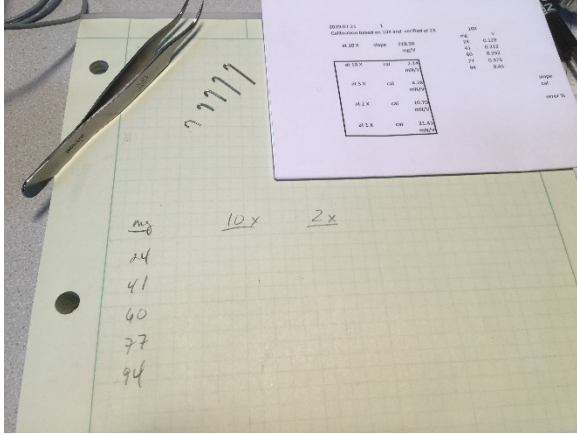

Get out the weight standards and write the weights on the piece of paper. Create columns for the appropriate gains.

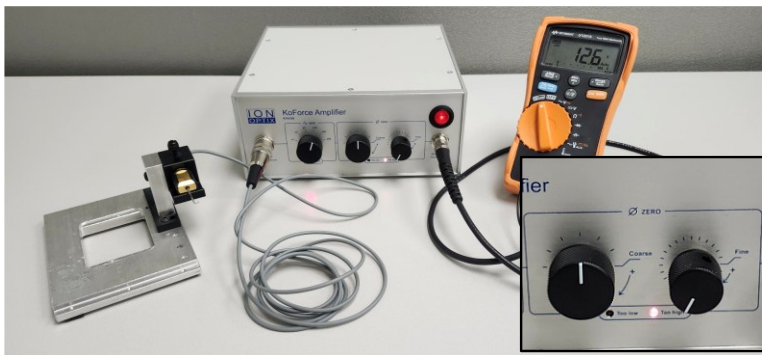

Set the KoForce gain to the appropriate setting (typically 5x and 10x).

When the red light indicates HIGH, the offset is too high.

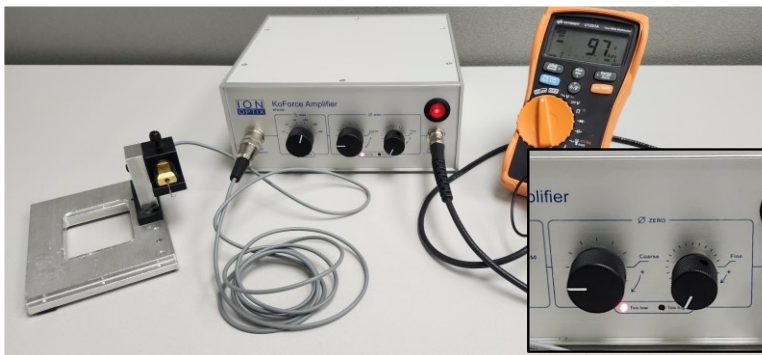

When the red light indicates LOW, the offset is too low.



Turn the coarse knob until the indicator lights are off, or when one turn immediately switches the other indicator light.

Adjust the fine offset until both red lights are off, and the voltmeter reads a value close to 0 V.

Let everything sit for at least 20 min to reach a temperature equilibrium. When you return, check the voltage for stability. When stable, bring the first weight just above the hook.

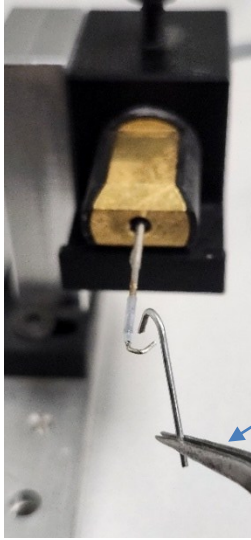

DO NOT PLACE IT ON THE HOOK.

Retract the forceps and let it drop onto the hook.

Open the forceps and let the weight drop onto the hook.



Read the voltage and write it down next to the relevant weight.



Now take off the weight by pushing it off carefully with the forceps.

DO NOT GRAB THE WEIGHT when it is on the hook. Let it fall to the table.

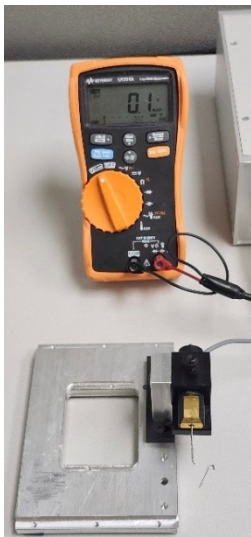

Read the voltage with weight off and record the background voltage.

Repeat for every weight at every gain setting. Note that the background voltage as well as each weight and measured voltage will be entered into the spreadsheet.

Put these values into the [KoForce Calibration Worksheet](#) (click the previous link to download or go to the IonOptix Resource Library and search “calibration”). The spreadsheet will automatically create the graphs for 5X and 10X. The plots should be straight lines. The absolute value of the error should be small, less than 3% error between the two measurements. If the graphs are not straight or the error is more than 3%, perform the calibration again.

Force Transducer Calibration

Update values in black boxes below

Date: _____ Initials: _____

	5X			10X		
	mg	V0/Vtot	V diff	mg	V0/Vtot	V diff
	24	0.01	0.074	0.064	0.01	0.16
	54	0.08	0.18	0.1	0.008	0.32
	91	0.012	0.24	0.228	0.012	0.69
	199	0.009	0.57	0.561	0.005	1.15

V at 5X

V at 10X

predicted values based on 10x

at 50x	cal	0.33		
		mN/V		
at 20x	cal	0.84		
		mN/V		
at 10 X	cal	1.67		
		mN/V		
at 5 X	cal	3.34		
		mN/V		
at 2 X	cal	8.36		
		mN/V		
at 1 X	cal	16.72		
		mN/V		

	5X	10X		
	mg	V at 5X	mg	V at 10X
	24	0.064	24	0.15
	54	0.1	54	0.312
	91	0.228	91	0.678
	199	0.561	199	1.145
	slope	335.92	slope	170.4939
		mg/V		mg/V
	cal mN/V	3.29		
	error %	-1.49%		
	<3% error?	pass		
	Sensitivity	pass		

Put today's date and your initials in the upper-left-hand corner.

Enter the weights, background voltages, and weighted voltages.

Plots are automatically generated.

Measured calibration values are shown in red; predicted calibration values are shown in purple.

Error is displayed as pass/fail (<3% = pass).

Save and print the spreadsheet sheet for later reference. Enter the calibration values into the appropriate corresponding tasks within IonWizard.

Assembling the System

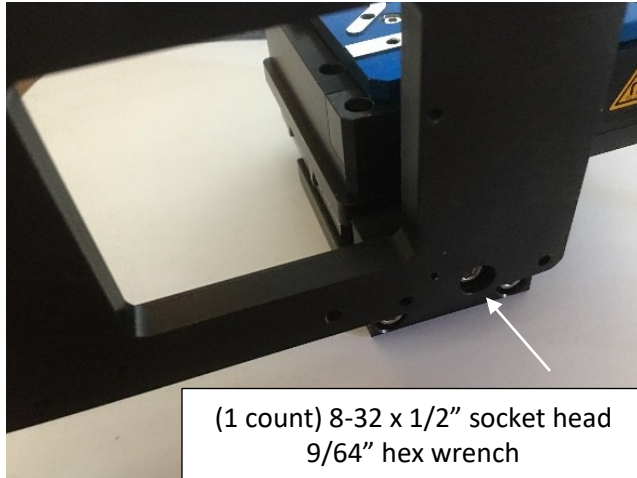

Place the voice coil pedestal flat on the table. Align the pins on the baseplate with the holes in the bottom of the pedestal. Attach the voice coil pedestal to the baseplate with the screw.

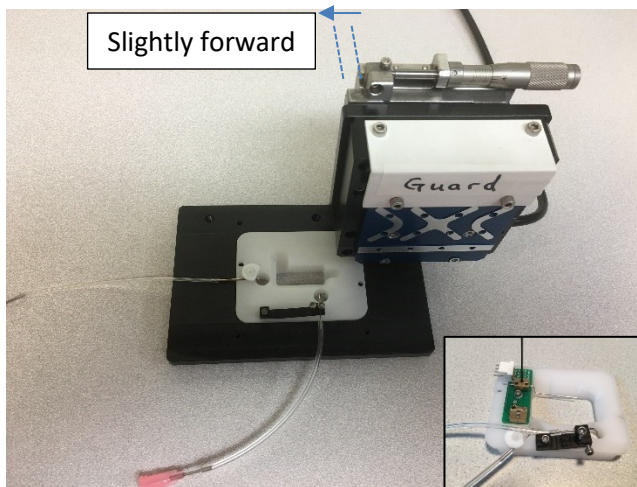

Put the chamber into the baseplate. If using the wide chamber (inset), the chamber will look a little different compared to the photos.

If necessary, adjust the manual micromanipulator a little forward (~4-12 mm) from its center position to assure later ease of assembly.

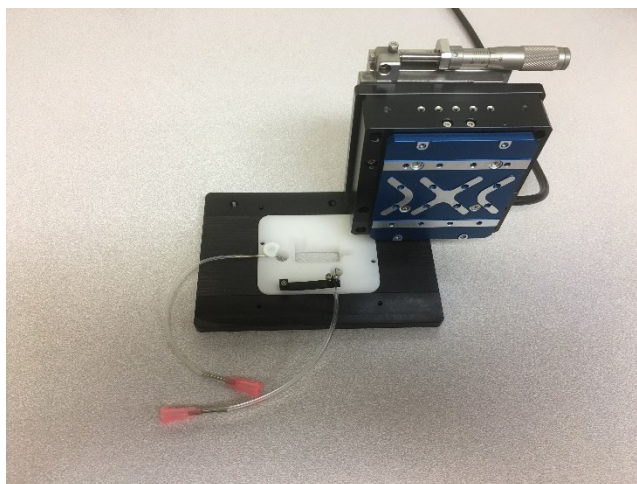

Remove the guard from the voice coil.

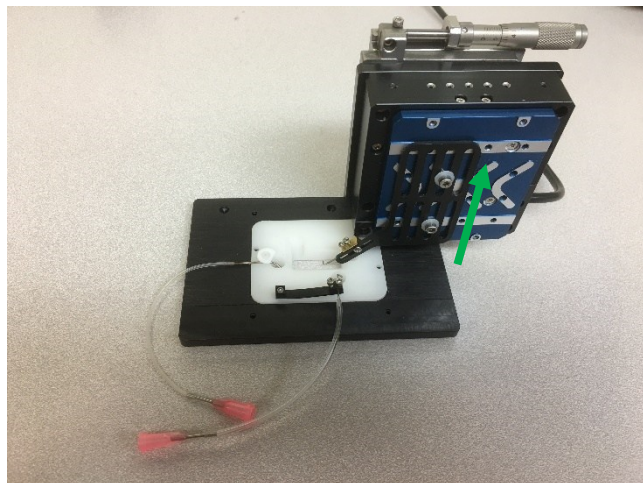
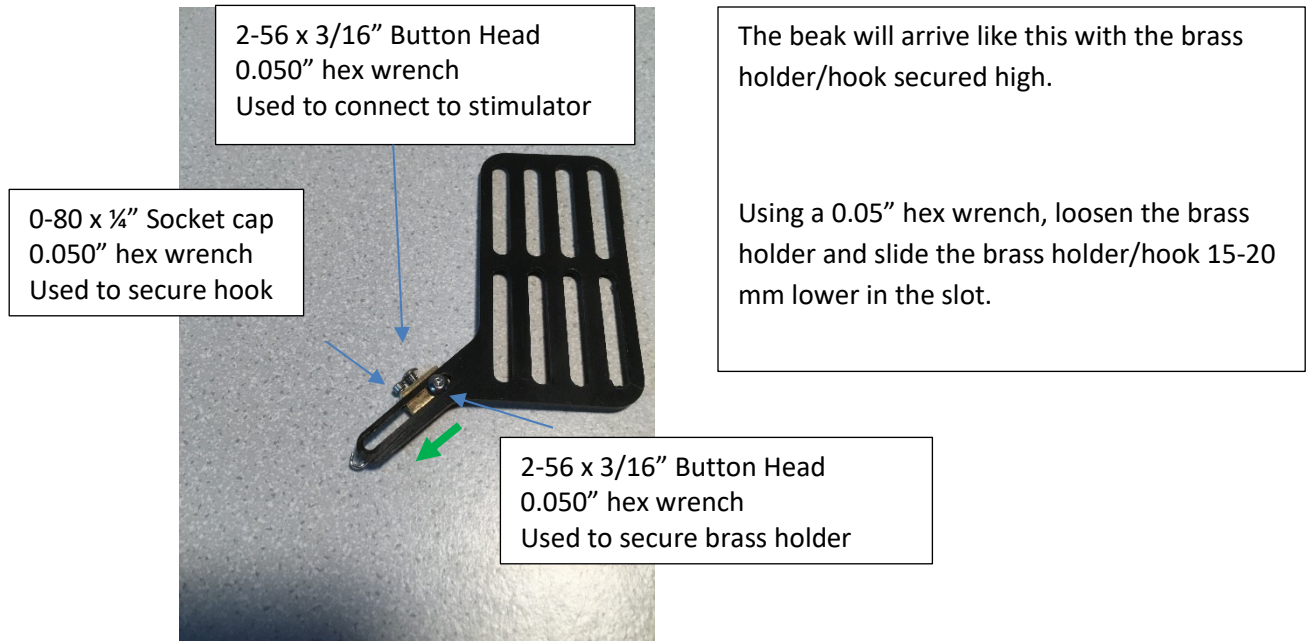

Attach the beak to the voice coil with the two M3 screws.

Place the beak as high as possible on the voice coil.

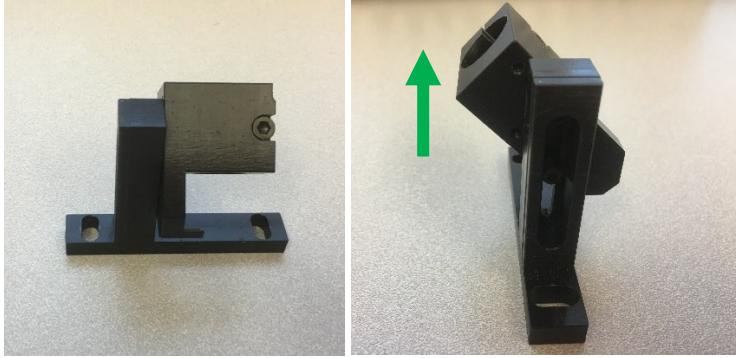

Make sure the force transducer holder is as high as possible on its pedestal.

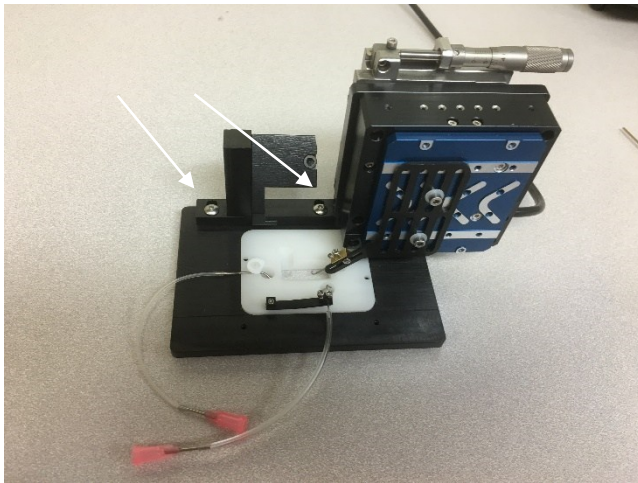

Attach the force transducer pedestal onto the baseplate.

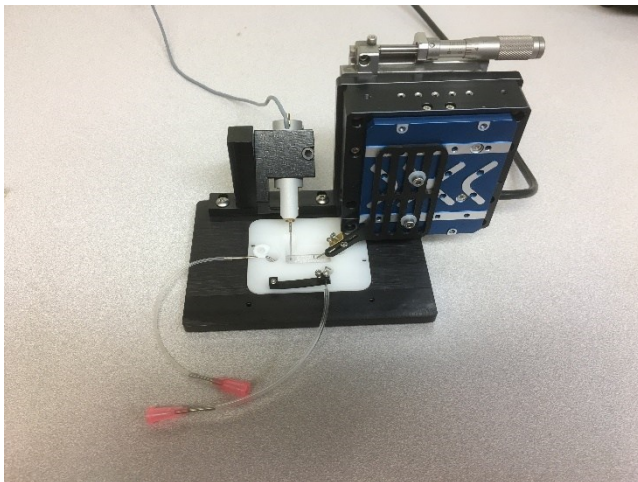

Place the force transducer into its holder. Make sure the hook is facing up.

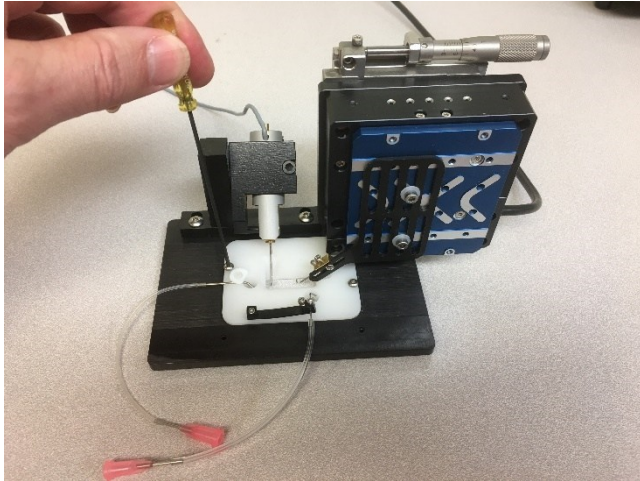

Secure the screws of the chamber.

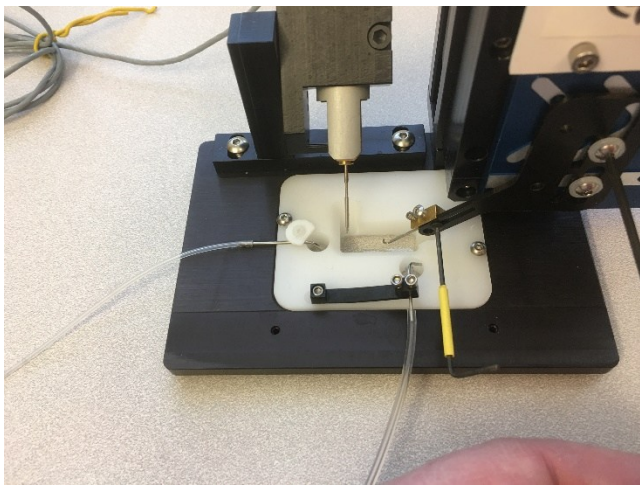

Adjust the brass hook holder on the motor side until the hook is about 1 cm from the other hook. Then adjust the black beak position until the hook is 1 mm above the glass coverslip.

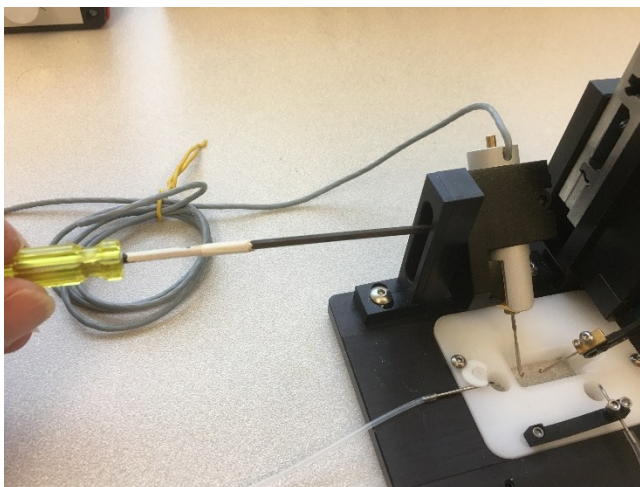

Adjust the force transducer holder position until the hook is 1-2 mm above the glass coverslip. BE VERY CAREFUL not to hit the glass with the hook.

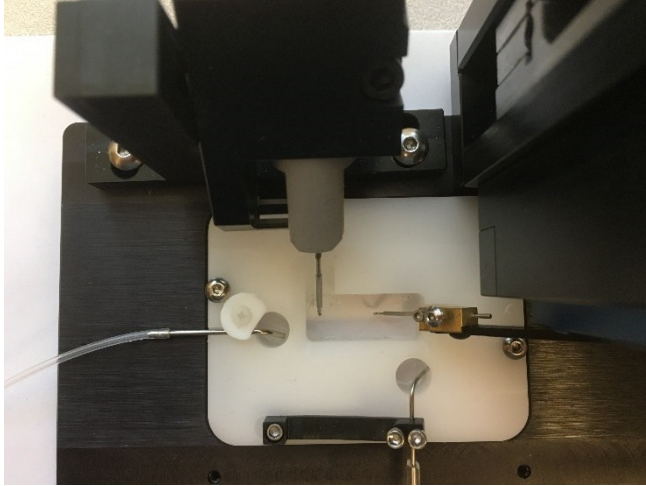

Adjust the position of the force transducer pedestal to assure that the hooks line up in parallel with the long axis of the chamber.

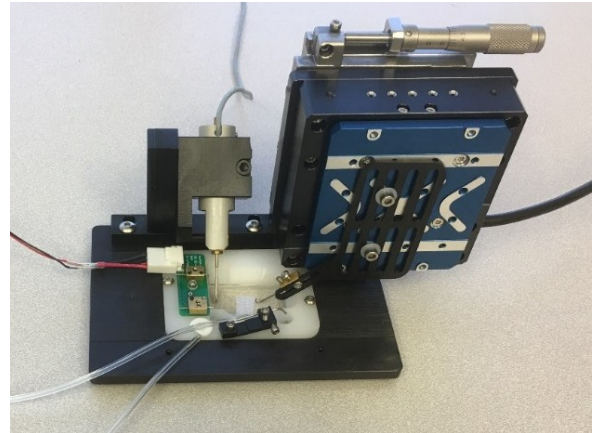
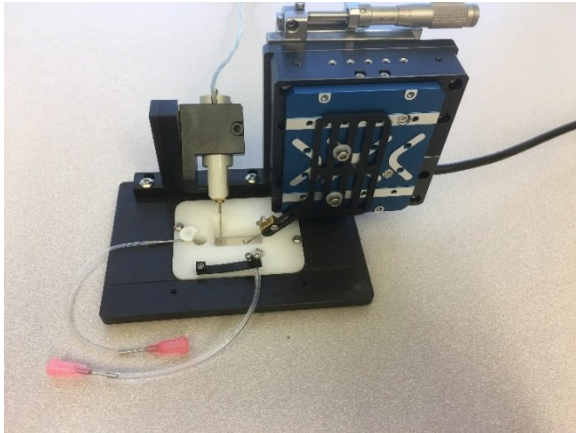

Finished assembly of the chamber and other components on the baseplate should look like one of these photos.



The electronics to be connected to the chamber components are:

- A. KoForce Bridge Amplifier
- B. MyoPacer Stimulator
- C. Fluorescence System Interface (FSI)
- D. Tissue Motor Controller



Attach motor cable to **MOTOR** connector of the Tissue Motor Controller.
Important: make sure to screw in the connector securely.

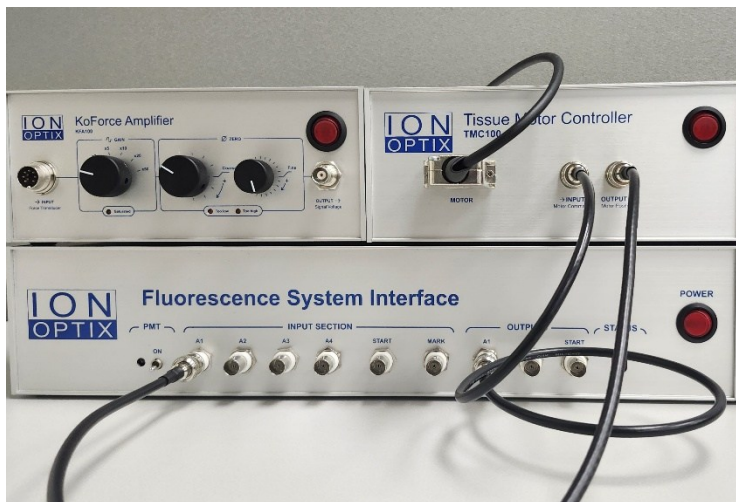

Attach a BNC cable to the motor controller **INPUT** jack. Attach the opposite end to an FSI **OUTPUT** BNC jack (**A1 OR A2**).

Attach a 2nd BNC cable to the motor controller **OUTPUT** jack. Attach the opposite end to an FSI **INPUT** BNC jack (**A1 – A4**).

NOTE: The Voice Coil motor will automatically zero its axis upon power up. **REMOVE GUARD BEFORE POWER UP.**



Attach the force transducer to the amplifier through the round **INPUT** connector.

Attach a BNC cable to the KoForce Amplifier **OUTPUT** BNC jack. Attach the opposite end to an FSI **INPUT** BNC jack (**A1 – A4**).



Attach a BNC cable between the stimulator Gate out (or Trigger out) and the FSI Mark.

Attach the stimulator leads from the stimulator to the hooks if stimulating through the hooks or directly to the chamber for field stimulation.

NOTE: If stimulating through the hooks, the positive (red) lead should be attached to the brass hook holder on the motor side, while the negative (black) lead should be attached to the back end of the force transducer.

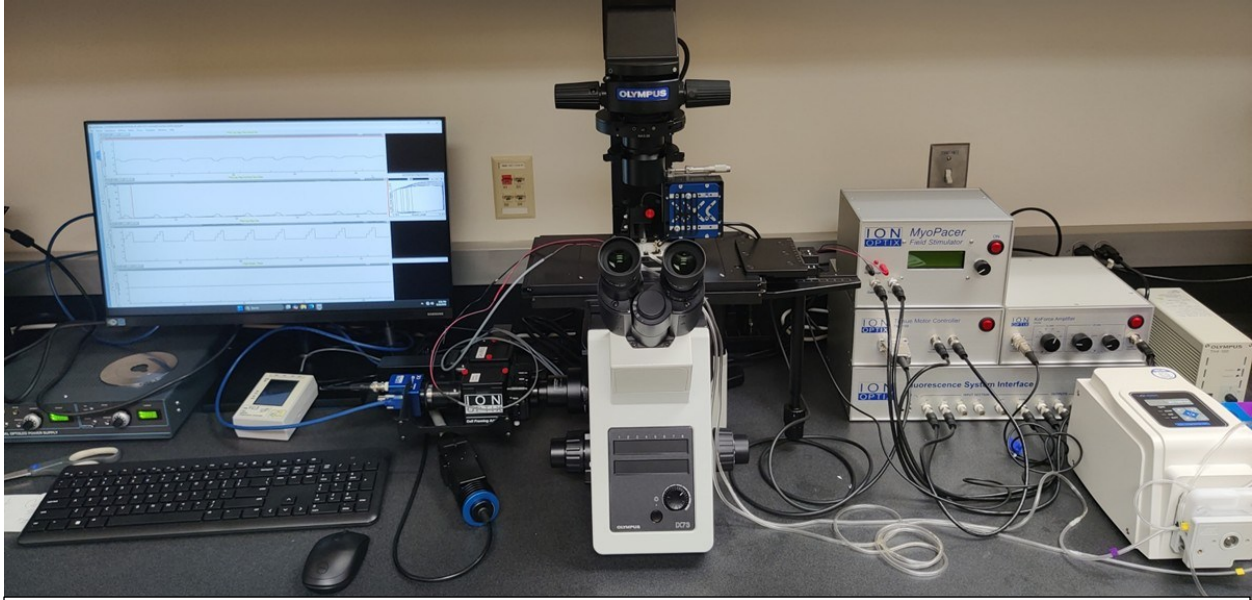

This is an example of a complete system set up on a microscope with optional LED light for calcium detection via Cal Red™ R525/650 (AAT Bioquest).

To the left of the microscope is the PC workstation, fluorescence LED illumination and power supply, perfusate flow heater controller, and camera and photomultiplier tubes on the microscope side port.

A chamber configured for living myocardial slices sits atop the microscope stage.

To the right of the microscope are the MyoPacer Field Stimulator (top), Tissue Motor Controller (middle-left), KoForce Amplifier (middle-right), and Fluorescence System Interface (bottom). A peristaltic pump (included with optional Tissue Slice Recording Accessories) is used to deliver and remove oxygenated fluid from the chamber.

Appendix: Troubleshooting

Below are a few potential problems and known solutions.

Problem	Solution
No Power	Make sure the power cord is plugged in firmly and connected to an active outlet. Unplug and check fuse. If necessary, replace with 2 Amp 5x20mm slow blow fuses.
Recorded voltage from bridge amplifier is stable at or near +10 V	If the 'Overload' light is on, then turn the gain to a lower amplification setting. If the 'high' is on and recorded voltage remains at +10 V, reduce the coarse offset to a lower setting. If the 'high' indicator remains on even at the lowest setting, call IonOptix for possible repair request.
Recorded voltage from bridge amplifier is stable at or near -10 V	If the 'low' is on, increase the coarse offset to a higher setting and/or increase the gain. If the 'low' indicator remains on even at the highest setting, call IonOptix for possible repair request.
Voice Coil motor is stuck at -2.5 mm or + 2.5 mm	To reset the voice coil motor, remove the power cord for 5 seconds. Stay clear of the motor when the power cord is reconnected. It will move to reference itself to a starting position in the center of its range. If it is still not center, call IonOptix for possible repair request.

Index

A

Aspirator height adjustment 13

C

Chamber Attributes 13

Component connections 27

Coverslip Repair 13

D

Declarations 1

Disposal 2

F

Fluid Flow Accessories 16

Force Transducer 4

Force Transducer Calibration 17

Force Transducer Connector 6, 7

Front Panel 6

Fuse 8

H

Hardware 4

I

Intended Use 1

K

KoForce Amplifier connections 28

KoForce Calibration Worksheet 21

KoForce Offset 8

KoForce Output 7

KoForce Overload Indicator Lights 7

KoForce Power Connection 8

KoForce Power Switch 7

M

Manual Length Adjustment 12

Motor Analog Input 10

Motor Analog Output 11

Motor Connector 10

Motor Controller 10

Motor Power Switch 11

Muscle types 3

S

Safety 1

Stimulation 3

System Assembly 22

T

Tissue Motor Controller connections 27

V

Voice Coil Motor 9

W

Warranty 2